











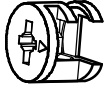
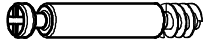

 Ø6,3x50 mm A1 x 20	 Ø12 mm A2 x 20	 4 mm A3 x 1	 Ø15x12 mm B1 x 2	 Ø5x44 mm B2 x 2
 Ø20 mm B3 x 2	 Ø4x16 mm D1 x 56	 Ø4x25 mm D2 x 8	 Ø4x30 mm D3 x 2	 Ø4x30 mm D4 x 8
 Ø8x30 mm E x 2	 Ø1,6x20 mm F x 169	 Ø8x36 mm G x 14	 H x 4	 K x 1
 Ø5x16 mm L x 12	 M1 x 3	 M2 x 4	 N x 4	 O x 4
 50g R x 1	 X x 4			

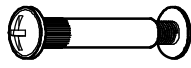
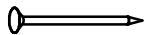
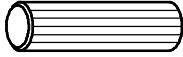

Box 1

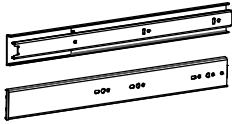
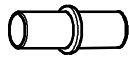
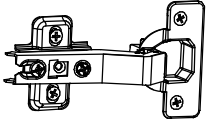
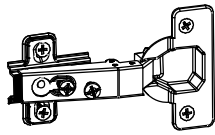
348x541x3 mm

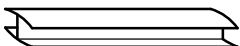

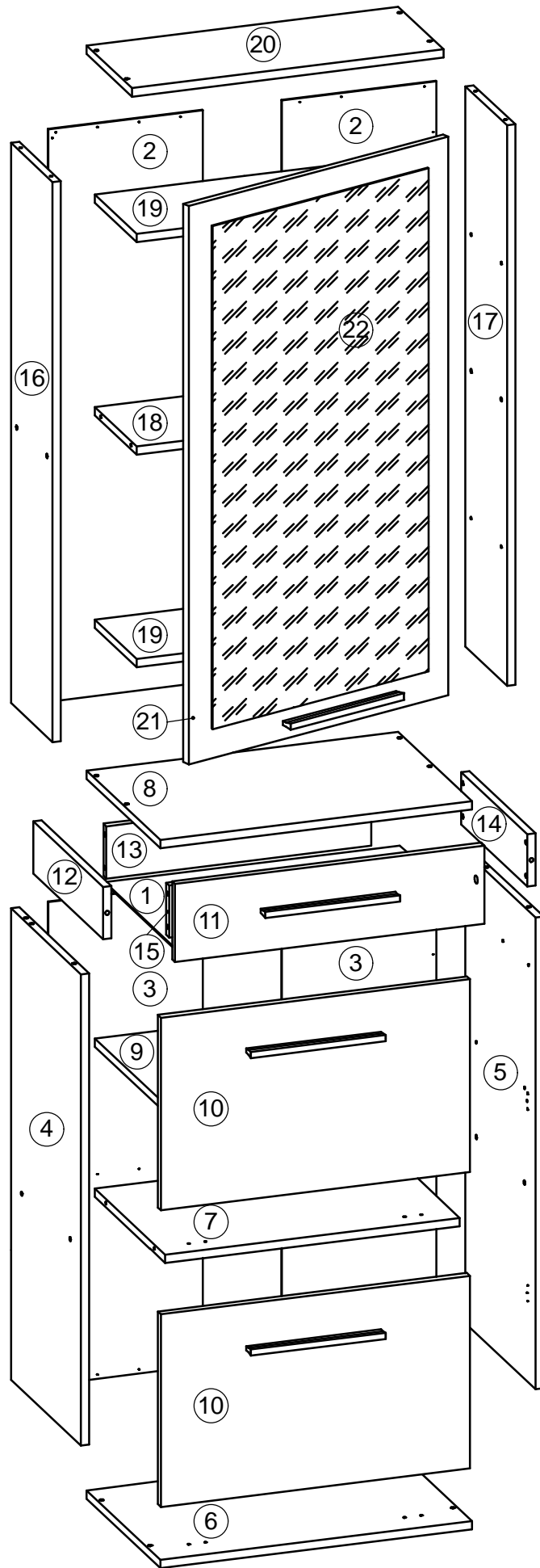
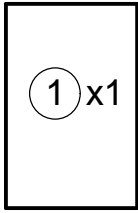
298x1102x3 mm

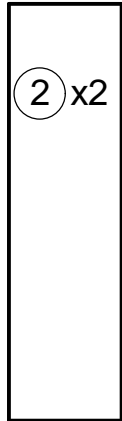

298x930x3mm

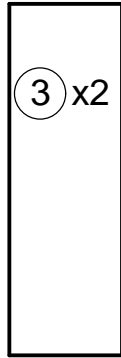

370x908x16 mm

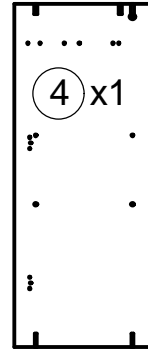

370x908x16 mm

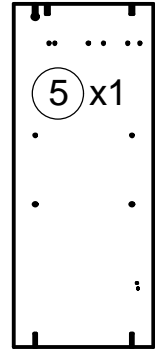

Fittings & Tools

390x600x16 mm

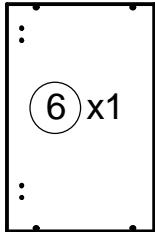

370x568x16 mm

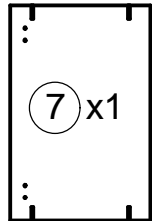

390x600x16 mm

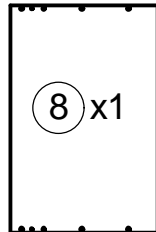

370x568x16 mm

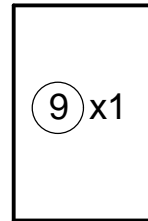

220x568x16 mm

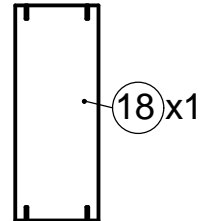

100x350x16 mm

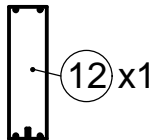

100x511x16 mm

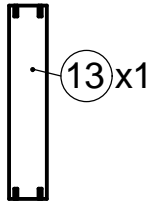

100x350x16 mm

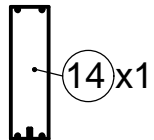

100x511x16 mm

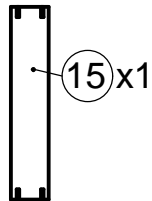

220x568x16 mm

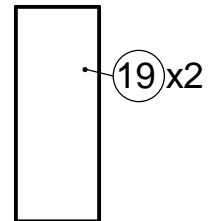

220x1079x16 mm

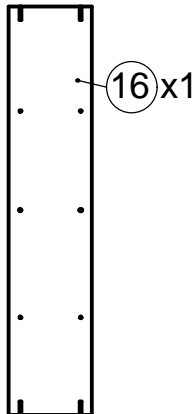

220x1079x16 mm

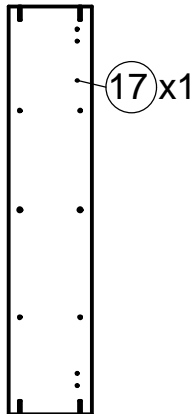

240x600x16 mm

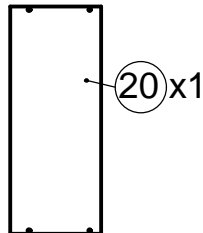

Box 3

595x1074x20 mm

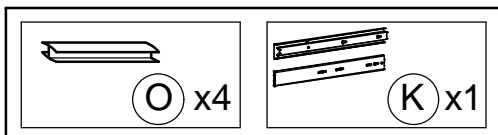
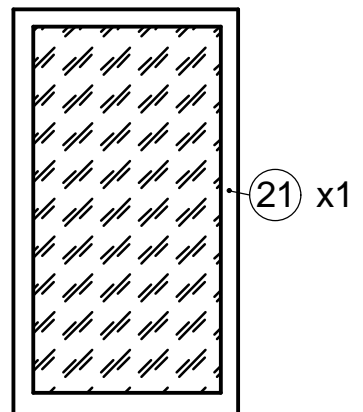

Box 2

370x595x16 mm

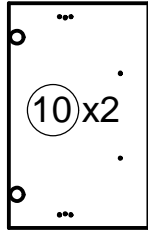

149x595x16 mm

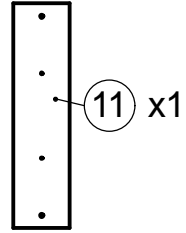

1



A1 x 4



A2 x 4

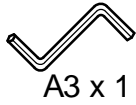

A3 x 1



B1 x 2



L x 4

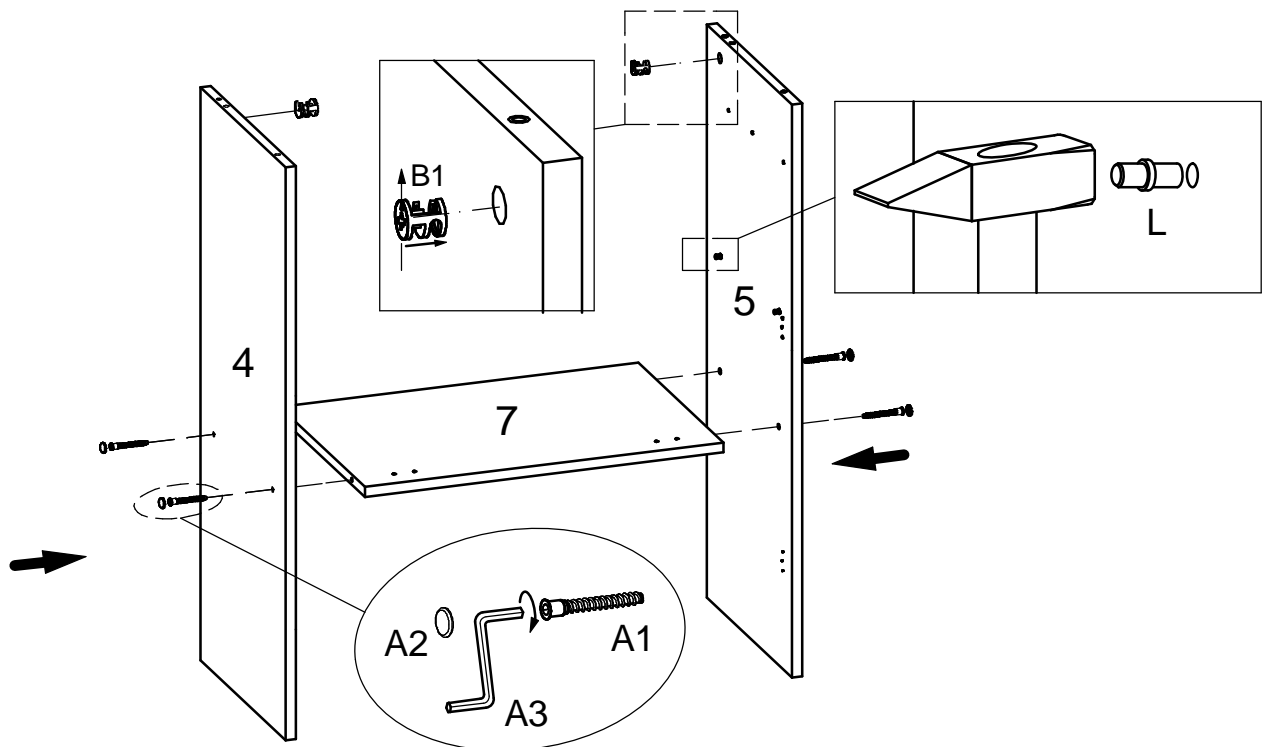
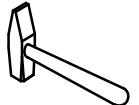



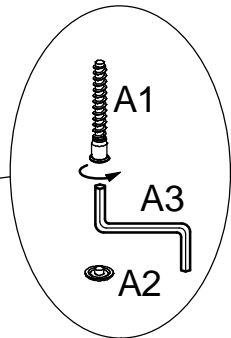
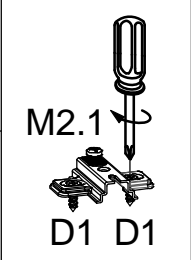
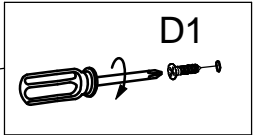
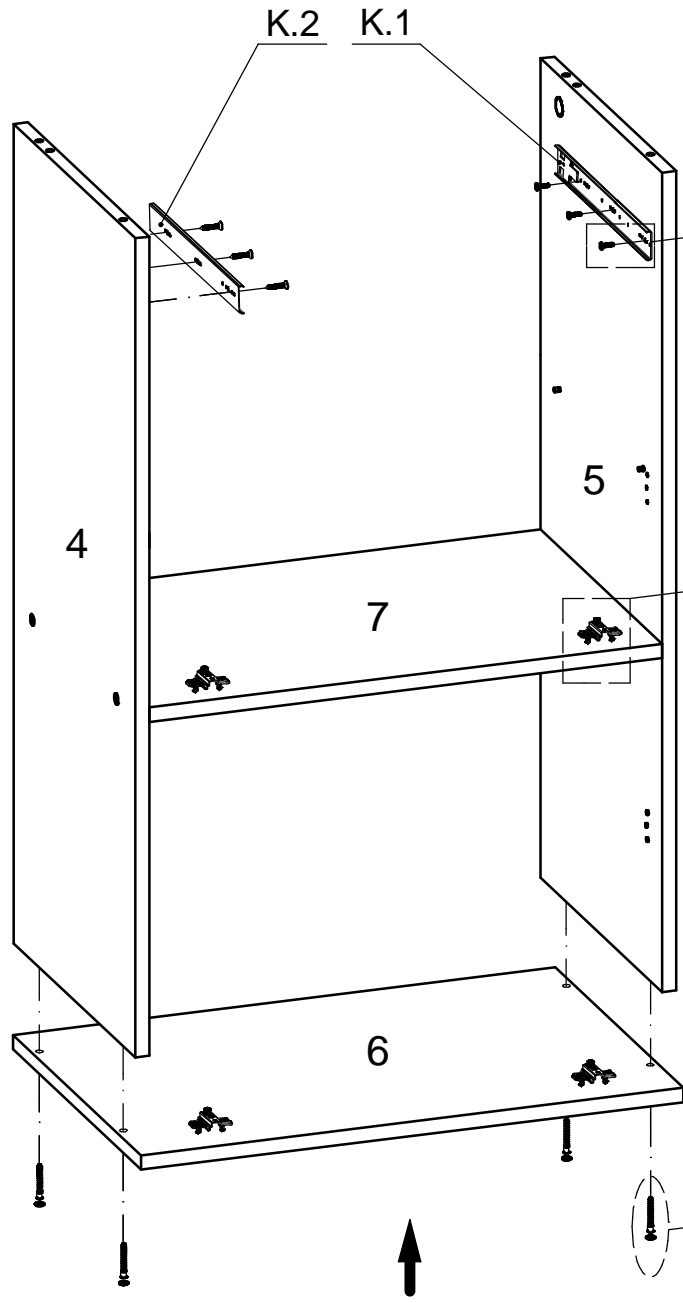
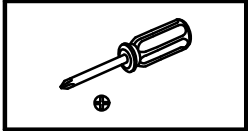

2

- A1 x 4
- A2 x 4
- A3 x 1
- D1 x 14
- K.1 x 1
- K.2 x 1
- M2.1 x 4

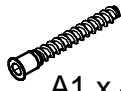

3

-  A1 x 4
-  A2 x 4
-  A3 x 1
-  L x 8

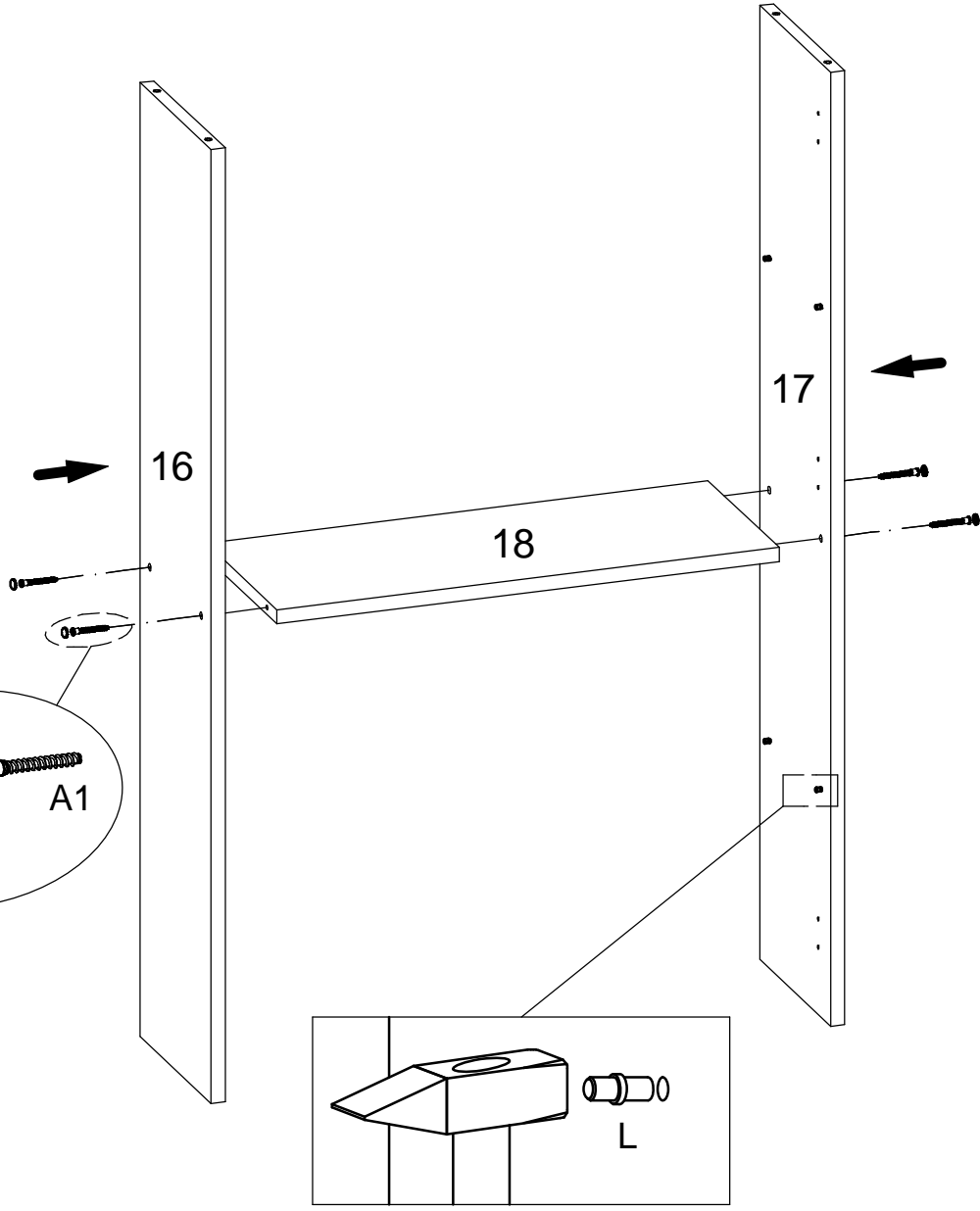
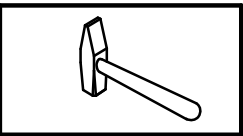

4

- A1 x 8
- A2 x 8
- A3 x 1
- D1 x 6
- M1.1 x 3

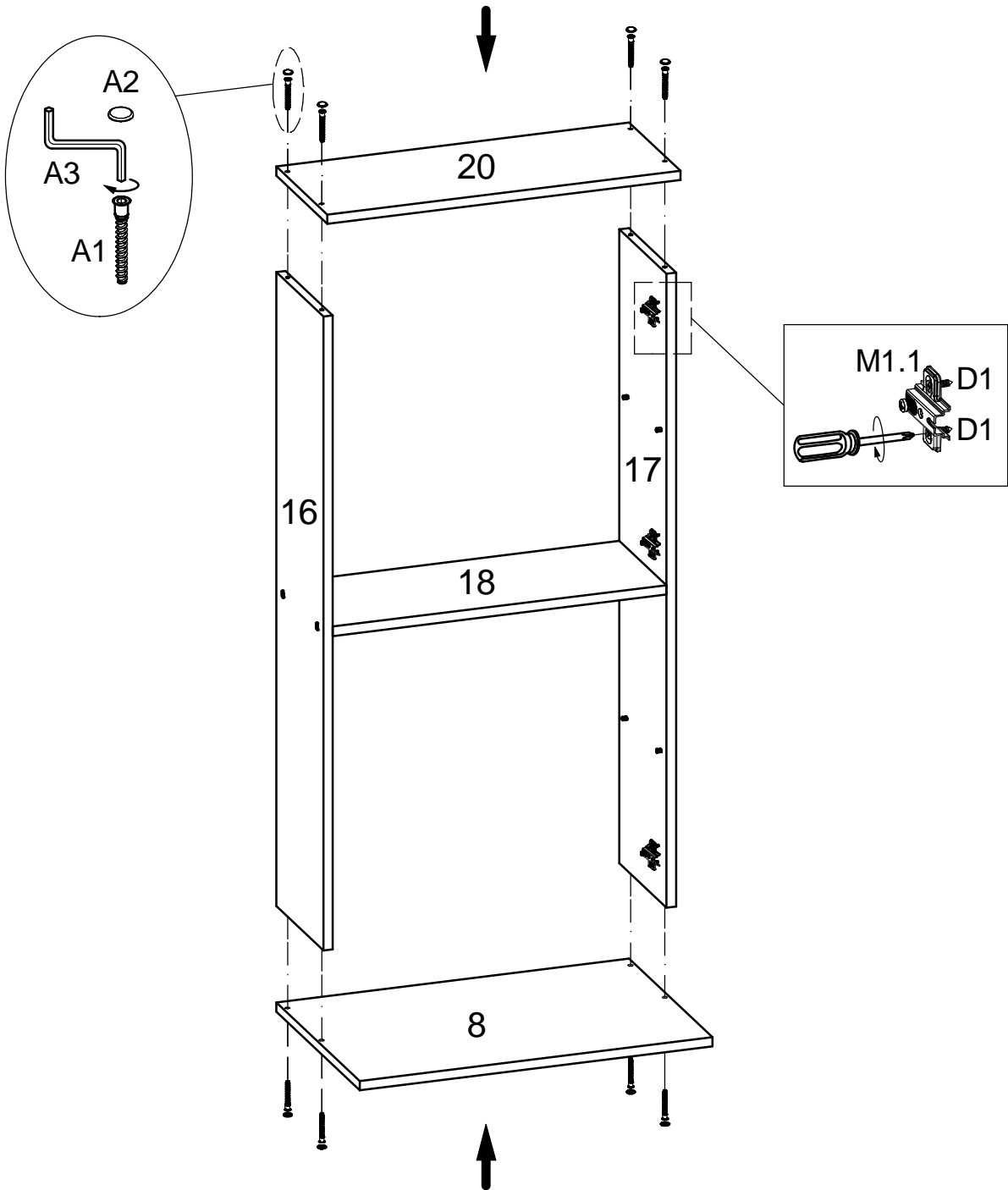
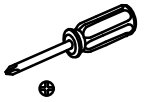

5

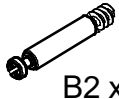

B2 x 2



B3 x 2

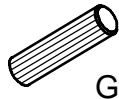

G x 4

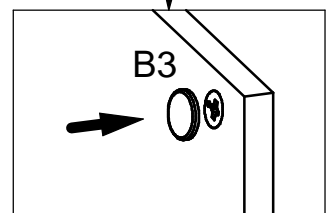
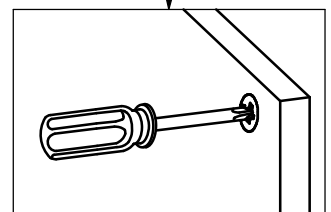
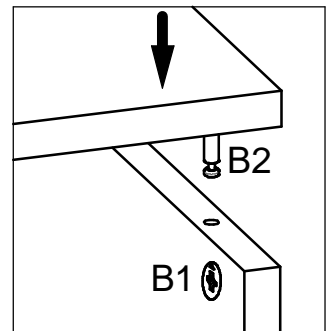
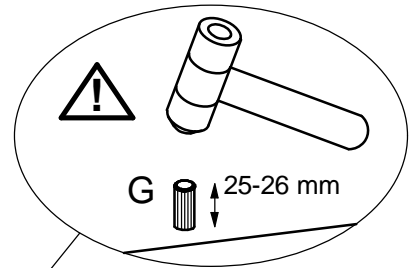
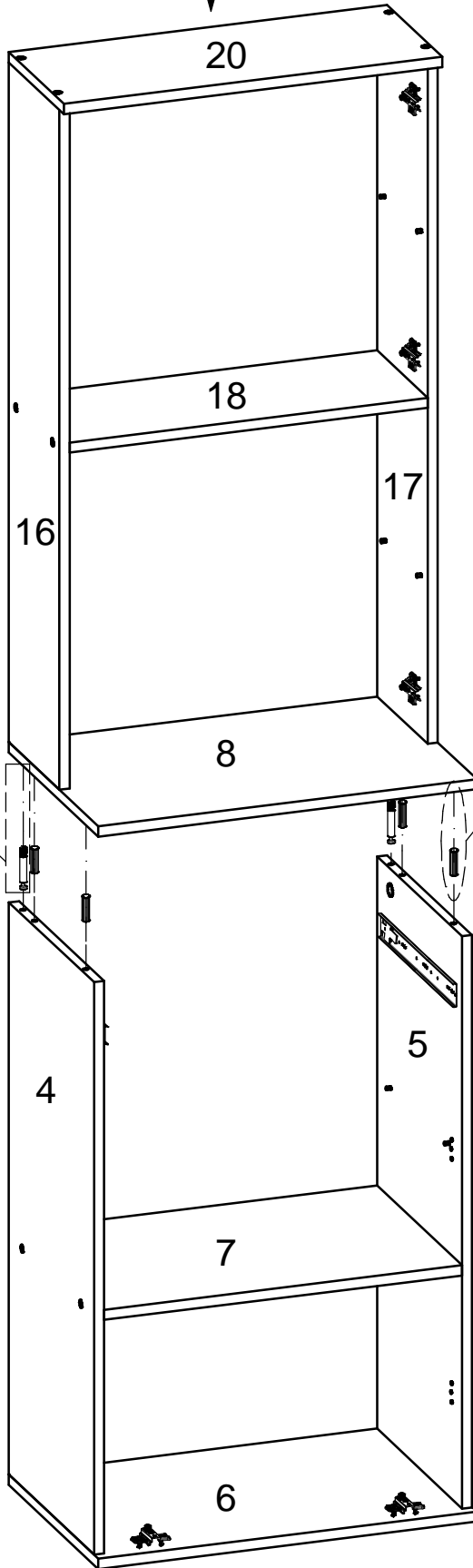
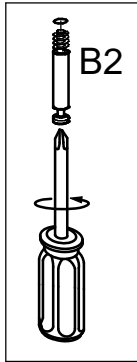
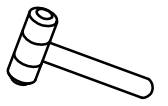
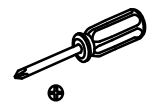

6



D2 x 8

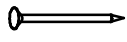

F x 125



N x 4

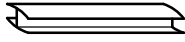

O x 4

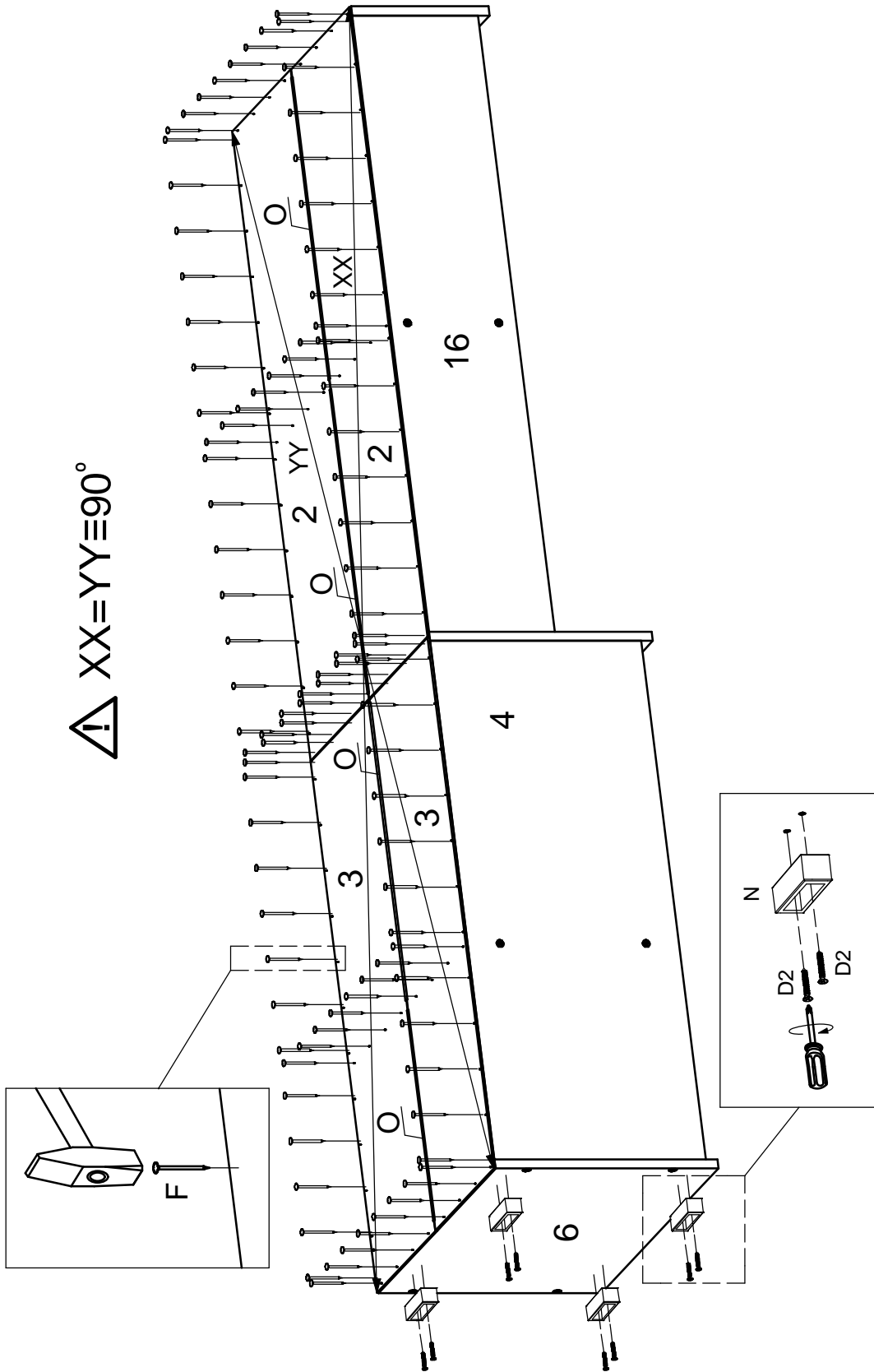
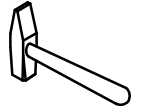
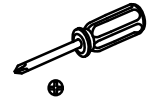

7



D1 x 30



D4 x 6

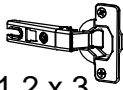

M1.2 x 3

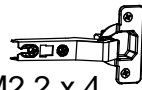

M2.2 x 4



H x 3



X x 4



D1

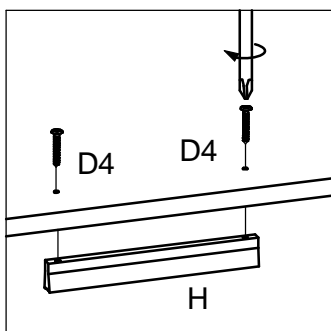
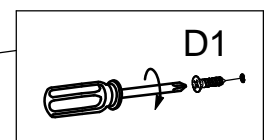
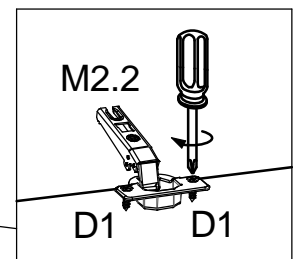
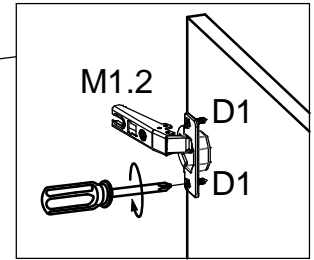
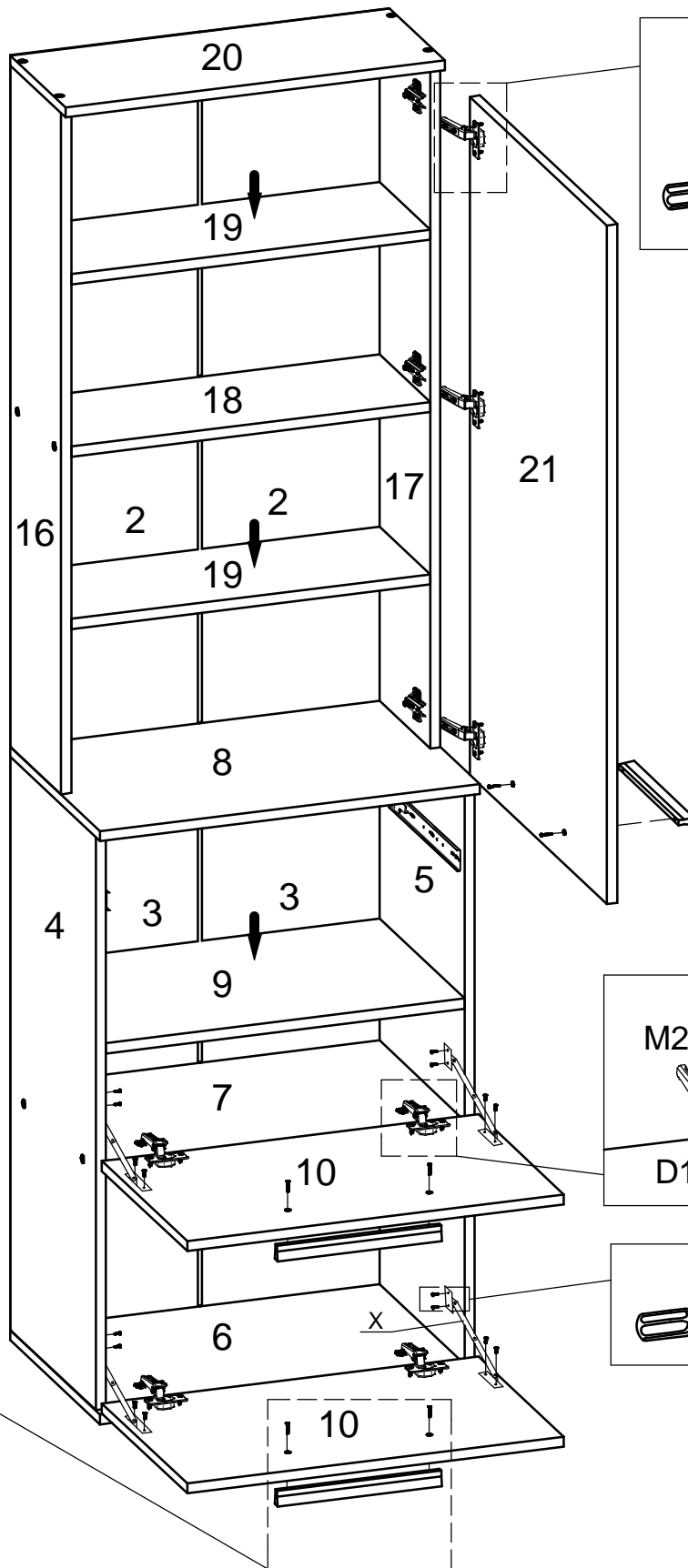

8

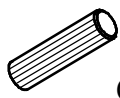

G x 8



R x 1

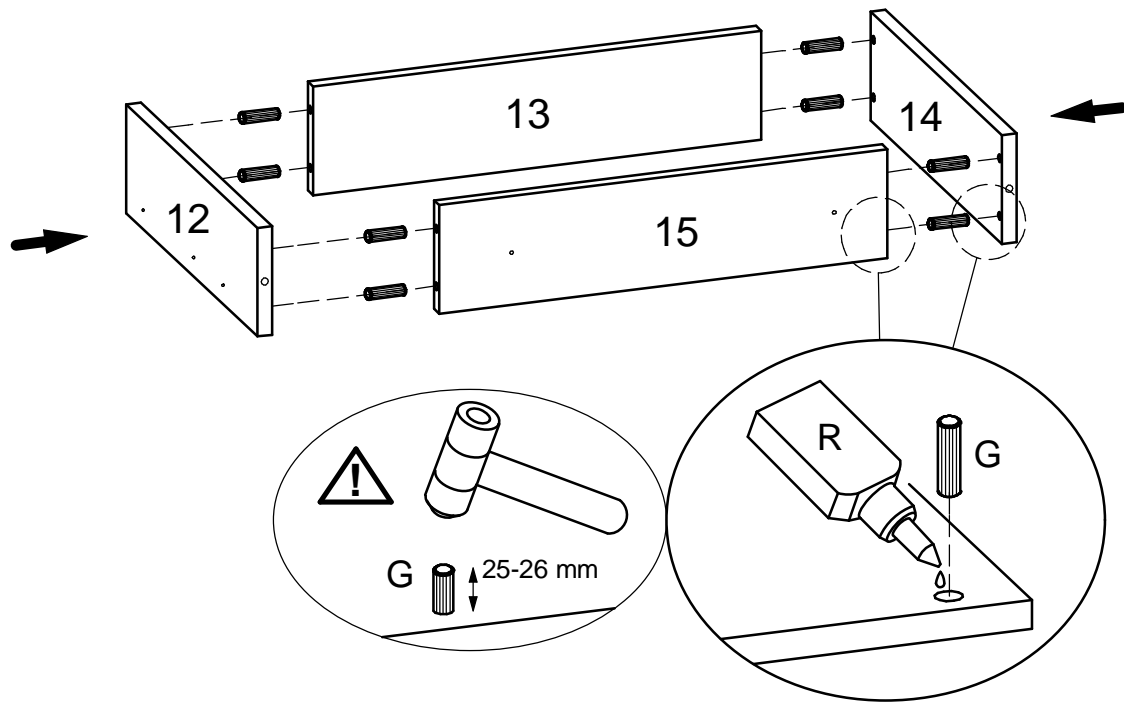
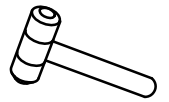

9

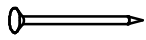

F x 44

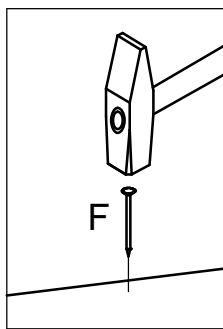
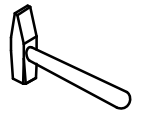

⚠ XX=YY≅90°

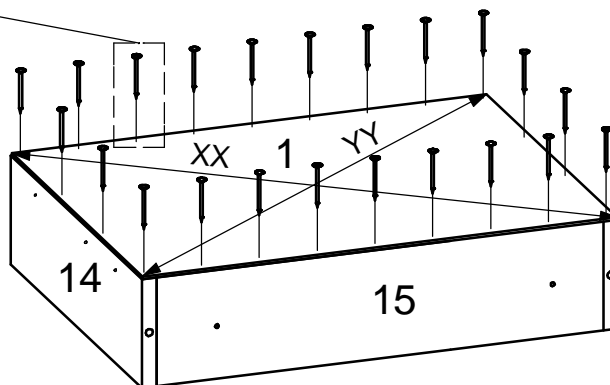

10



D1 x 6



K.3 x 1



K.4 x 1

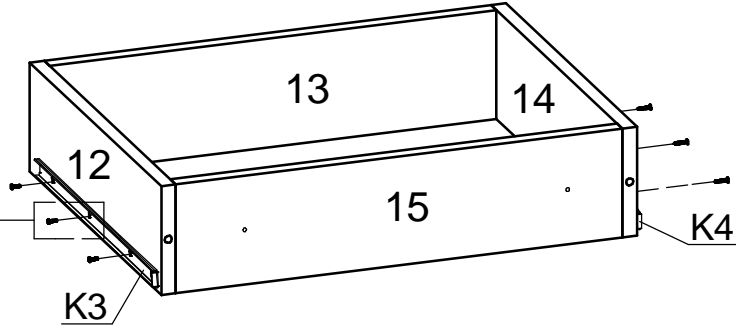
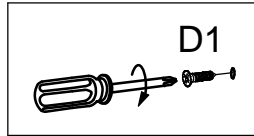
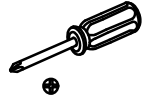

11

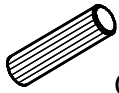

G x 2

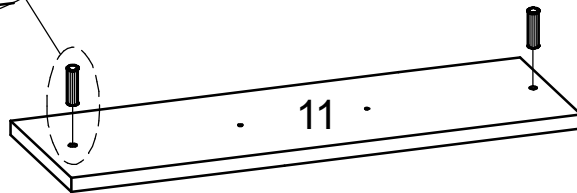
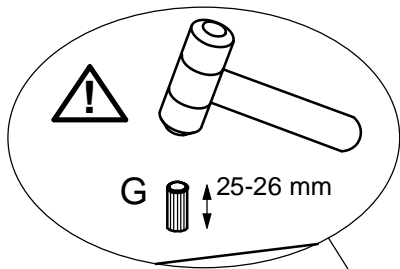
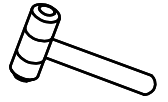

12



D4 x 2

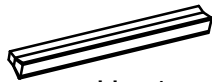

H x 1

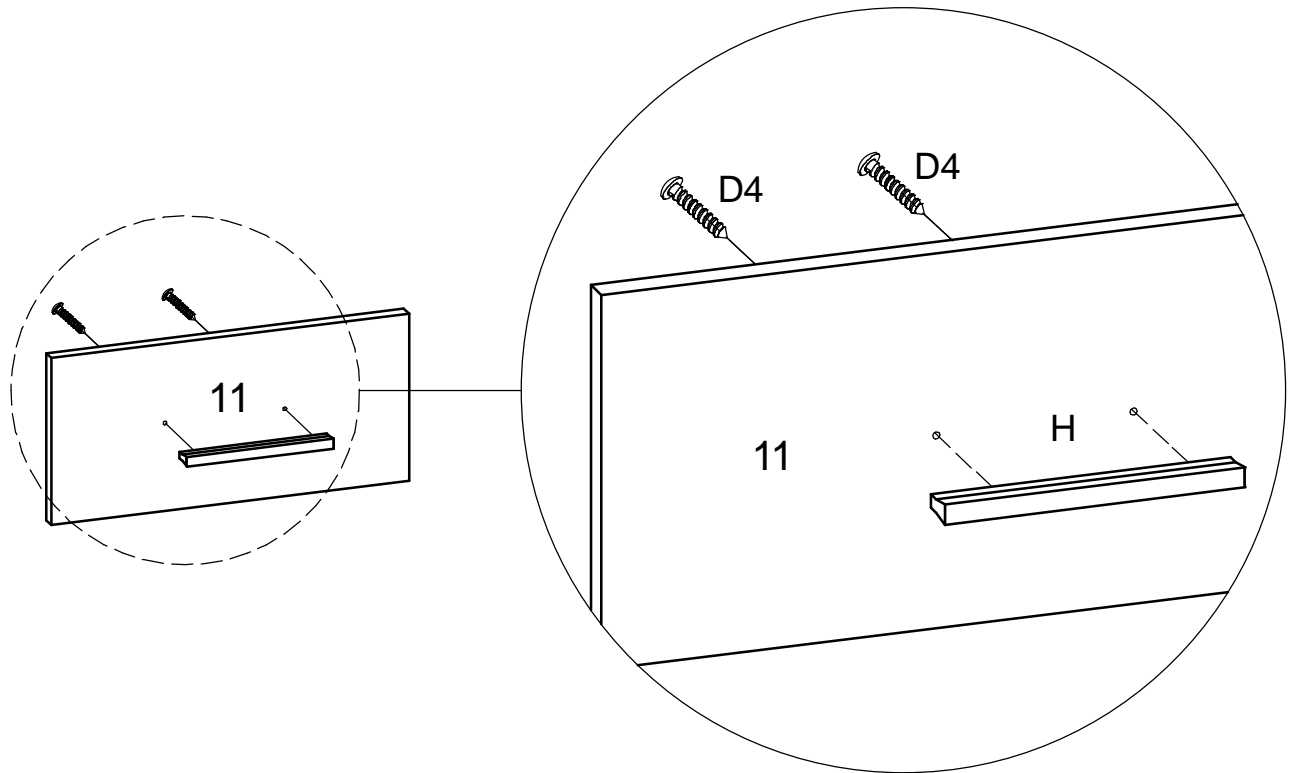
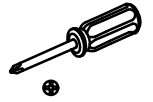

13



D3 x 2

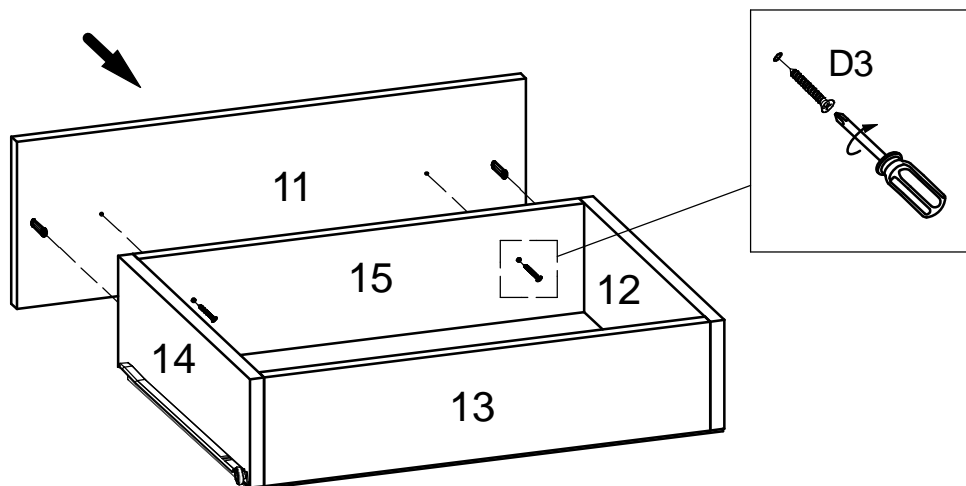
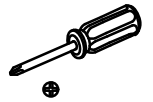

14

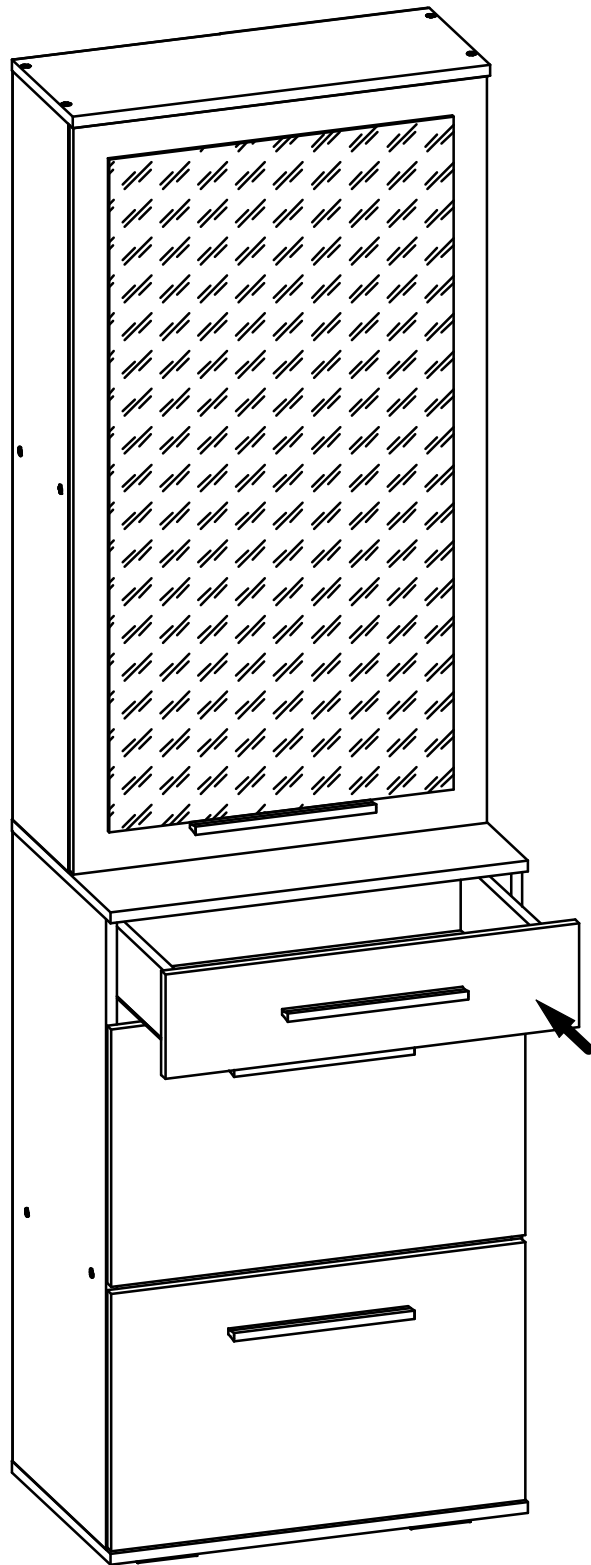



Ex 2



Ø8

